



# INSTALLATION INSTRUCTIONS

Accessory  
**ROOF RACK**  
P/N 08L02-SWA-100

Application  
**2008 CR-V**

Publications No.  
**All 37529**

Issue Date  
**AUG 2007**

## PARTS LIST

Front roof rack  
(with "FRONT" sticker)



Rear roof rack



8 Special nuts



## TOOLS AND SUPPLIES REQUIRED

Flat-tip screwdriver  
Shop towel  
Hex wrench  
Ratchet  
T40 TORX socket

## Illustration of the Roof Rack Installed on the Vehicle

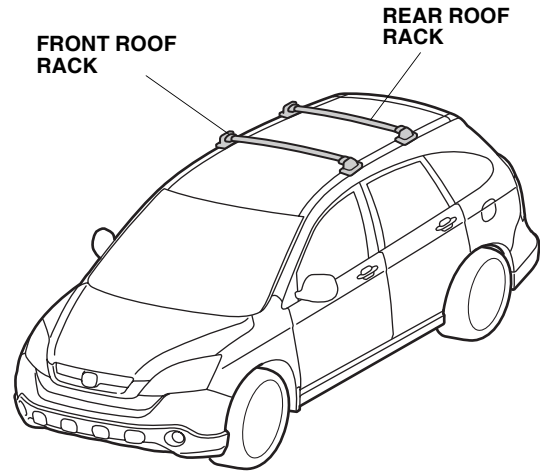

## INSTALLATION

**NOTE:** Be careful not to damage the roof and other finished surfaces of the body when installing the roof rack.

- Using a flat-tip screwdriver wrapped with a shop towel, remove the four roof trim covers (four retaining tabs for each cover).

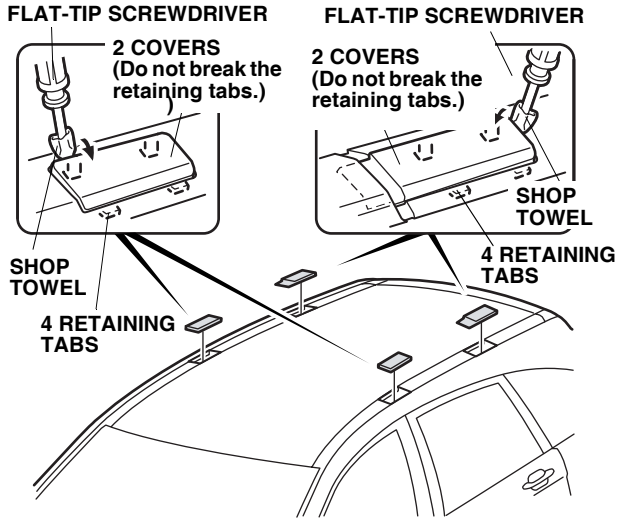

- Clean the paint off of the mounting studs. Thread on a special nut until you feel resistance, then turn it an additional 90°. Remove the nut, and blow the nut and stud clean with compressed air. Repeat this process until the nut threads all the way on.
- Repeat step 2 for all of the remaining studs.

- Position the front and rear roof racks on the vehicle and install the eight special nuts using a T40 TORX socket. Make sure the rubber alignment stud is positioned through the hole in the roof rack. Torque the special nuts to 20 N·m (14 lb-ft).

NOTE: The front rack has a label.

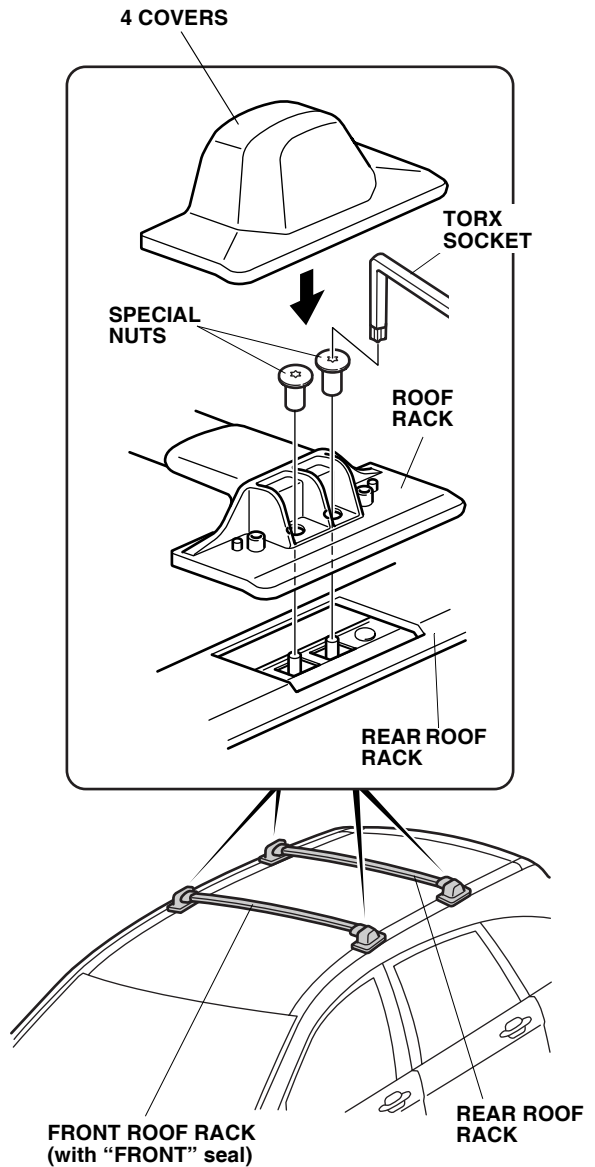

- Reinstall the four covers on the front roof rack.

6. After installing each cover, check that the rubber from the roof rack cover is not protruding. If it is, push the rubber into position using a plastic spatula.

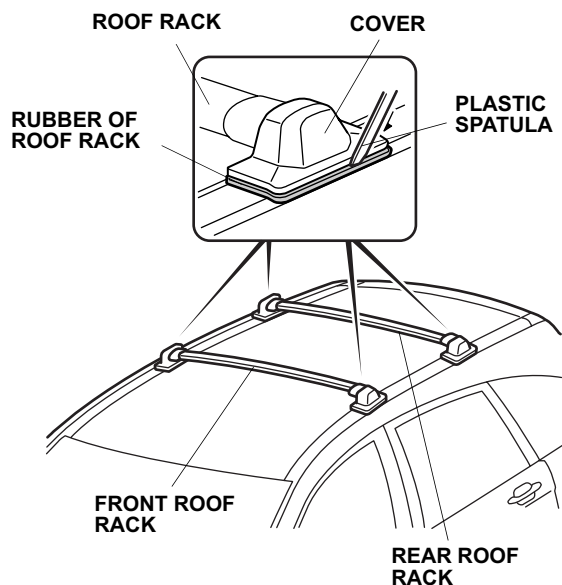

7. After installing the roof rack, rock each rack to make sure it is secure.

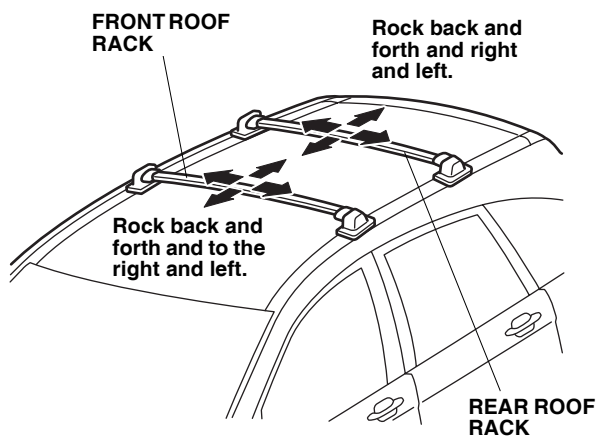

8. Give the covers (removed in step 1) to your customer in the event the roof rack is removed.